



JUKI

Union Special

INSTRUCTIONS / ILLUSTRATED PARTS LIST



35800 LAPSEAMER WITH
MECHANICAL DRIVE PULLER AND
SPECIAL SOFT STITCH FORMATION PARTS

CATALOG NO.
PT0601

FIRST EDITION
SUPPLEMENT TO
PT9804

STYLES

35800DNUB8	35800DNUB9
35800DNWB8	35800DNWB9
35800DRUB8	35800DRUB9
35800DRWB9	35800PZB32
35800PZB36	

Manual No. PT0601 Adjusting Instructions & Illustrated Parts List for
35800 Series Balloon Stitch Machines

First Edition Copyright 2006
By
Union Special Corporation Rights Reserved In All Countries
Printed in U.S.A. May 2006

IDENTIFICATION OF MACHINES

Each UNION SPECIAL machine is identified by a style number, which is stamped into the style plate affixed to the middle of the machine under the tension assembly.







The serial number is stamped in the casting at the right rear base of the machine.

CLASS DESCRIPTION

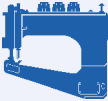
High Speed, Feed-Off-The-Arm High Throw Machines, Two and Three Needle, Left Needle In Front. Light Weight Presser Bar Mechanism, Adjustable Looper Avoid, Space in Front of Needles 8" (203.2 mm), Double Disc Looper Thread Take-Up, Automatic Enclosed Type Oiling System and Filter Type Oil Pump, Visual Sight Oil Action and Supply Gauges. Special soft stitch formation parts.

STYLE OF MACHINES

35800DNUB	DOUBLE LAPSEAM. Three needle, high capacity, differential feed with upper driven roller feed. -Typical Application- For in and out seaming on heavy weight denim garments. Seam Specification 401 LSc-3. Standard gauge Numbers 8 [1/8", 3.2mm] and 9 [9/64", 3.6mm]. Recommended needle 130GS, size 140/054. Maximum recommended speed 4500 R.P.M.. .094 step sewing parts. .468 (15/32, 11.9mm) narrow roller.
35800DNWB	DOUBLE LAPSEAM. Three needle, high capacity, differential feed with upper driven roller feed. -Typical Application- For in and out seaming on heavy weight denim garments. Seam Specification 401 LSc-3. Standard gauge Numbers 8 [1/8", 3.2mm] and 9 [9/64", 3.6mm]. Recommended needle 130GS, size 140/054. Maximum recommended speed 4500 R.P.M.. .094 step sewing parts. .588 (19/32, 15.0mm) wide roller.
35800DRUB	DOUBLE LAPSEAM. Three needle, high capacity, plain feed, upper driven, roller feed. Feed Dogs have higher teeth on front. - Typical Application- For seat seaming, in and out seams on medium to heavy weight denim garments. Seam Specifications 401LSc-3. Standard gauge Numbers 8 [1/8", 3.2mm] and 9 [9/64", 3.6mm]. Recommended needle 130GS, size 140/054. Maximum recommended speed 4500 R.P.M.. .094 step sewing parts. .468 (15/32", 11.9mm) narrow roller.
35800PZB	Same as 35800DRUB except with reverse teeth roller.
35800DRWB	DOUBLE LAP SEAM. Three needle, high capacity, plain feed, upper driven, roller feed (wide roller). Feeds have higher teeth on front of feeds. - Typical Application- For seat seaming, in and out seams on medium to heavy weight denim garments. Seam Specifications 401LSc-3. Standard gauge 9 [9/64", 3.6mm]. Recommended needle 130GS, size 140/054. Maximum recommended speed 4500 R.P.M.. .094 step sewing parts. .588" (19/32", 15mm) wide roller.

						
All Styles	130GS 3	6	3.6mm, or 7.2mm with center needle removed	2.1~3.6 (3.2 standard)	9.0mm	4500 RPM maximum

35800 BALLOON STITCH					
STANDARD THROAT PLATE	STANDARD STYLE	BALLOON STITCH MACHINE STYLE	RETRO FIT KIT	NEW THROAT PLATE	THROAT PLATE I.D. MARK
35824DN8	35800DNU8	35800DNUB8	29480BEB	35824ED8	ED8
35824DN9	35800DNU9	35800DNUB9	29480BDY	35824EC9	EC9
35824DX8		35800DNWB8	29480BEA	35824DZ8	DZ8
35824DX9		35800DNWB9	29480BDZ	35824DZ9	DZ9
35824DQ8	35800DRU8	35800DRUB8	29480BEC	35824EF8	EF8
35824DQ9	35800DRU9	35800DRUB9	29480BED	35824ED9	ED9
35824DQ8	35800PZ32	35800PZB32	29480BEC	35824EF8	EF8
35824DQ9	35800PZ36	35800PZB36	29480BED	35824ED9	ED9
35824DQW9	35800DRW9	35800DRWB9	29480BEH	35824EF9	EF9

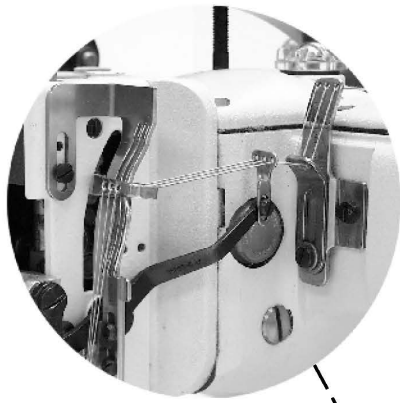

1 or 2 drops of oil twice a week

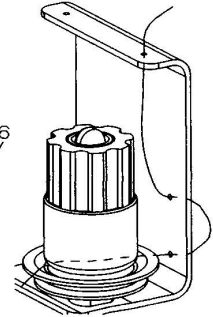
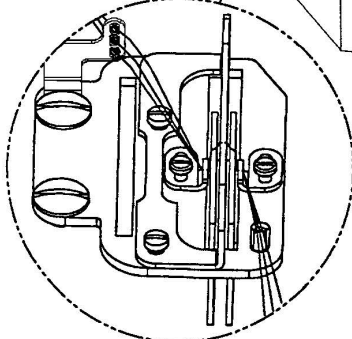
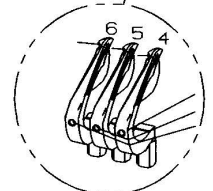
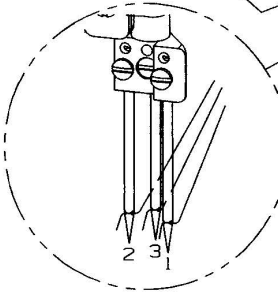

- A Oil Fill Cap & Oil Sight
- B Oil Level Gage
- C Pump Primer Screws
- D Oil Fill Cap & Oil Sight
- E Oil Level Gage
- F Arm Oil Drain Plug
- G Looper Position knob

MINIMUM OIL LEVEL
MAXIMUM OIL LEVEL

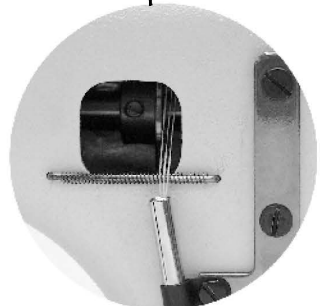

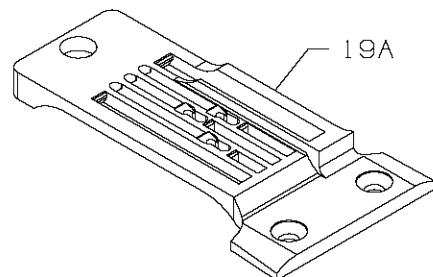
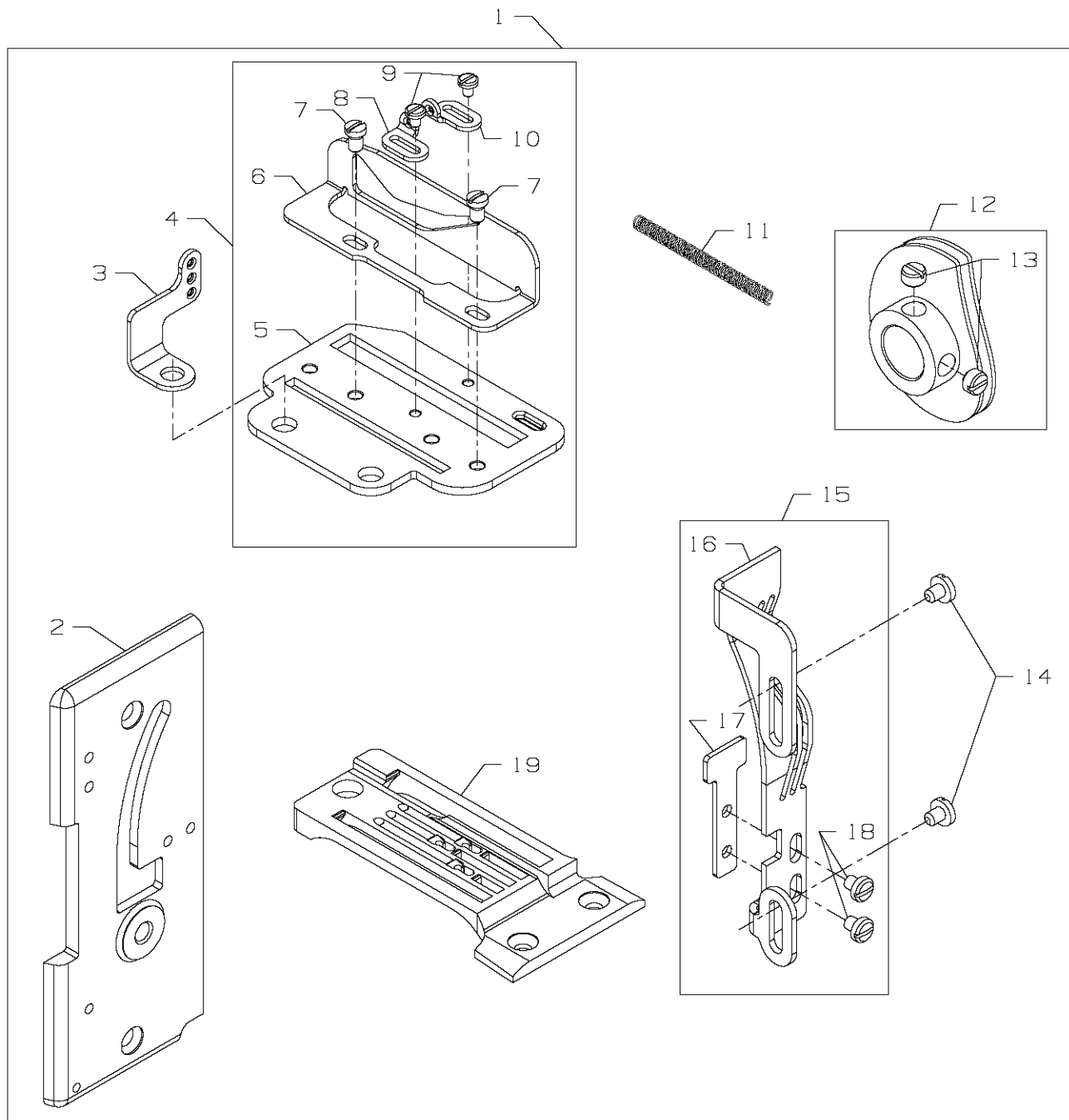

BALLOON STITCH PARTS

Ref. No.	Part No.	Description	Amt. Req.
1.	29480BEB	Kit of Parts, for 35800DNUB8	1
-	29480BDY	Kit of Parts, for 35800DNUB9	1
-	29480BEA	Kit of Parts, for 35800DNWB8	1
-	29480BDZ	Kit of Parts, for 35800DNWB9	1
-	29480BEC	Kit of Parts, for 35800DRUB8, 35800PZB32	1
-	29480BED	Kit of Parts, for 35800DRUB9, 35800PZB36	1
-	29480BEH	Kit of Parts, for 35800DRWB9	1
2.	35882K	Front Cover	1
3.	50658A	Looper Thread Eyelet	1
4.	29476CA	Cast-Off Plate Assembly	1
5.	35804B	Cast-Off Plate	1
6.	36204A	Cast-Off	1
7.	22KH	Screw	2
8.	52958C	Eyelet	1
9.	73A	Screw	2
10.	52958F	Eyelet	1
11.	35853AN	Looper Thread Spring	1
12.	35823D	Double Disc Take-up Cam	1
13.	22580	Screw	2
14.	22704	Screw	2
15.	29476CB	Needle Thread Take-up Assembly	1
16.	35804C	Needle Thread Take-up	1
17.	35804B	Needle Thread Strike-off	1
18.	25B	Screw	2
19.	35824DN8	Throat Plate, I. D. marked "ED8", for 29480BEB kit of parts	1
-	35824DN9	Throat Plate, I. D. marked "EC9", for 29480BDY kit of parts	1
-	35824DQ8	Throat Plate, I. D. marked "EF8", for 29480BEC kit of parts	1
-	35824DQ9	Throat Plate, I. D. marked "ED9", for 29480BED kit of parts	1
19A.	35824DX8	Throat Plate, I. D. marked "DZ8", for 29480BEA kit of parts	1
-	35824DX9	Throat Plate, I. D. marked "DZ9", for 29480BDZ kit of parts	1
-	35824DQW9	Throat Plate, I. D. marked "EF9", for 29480BEH kit of parts	1

Appearance of Standard vs. Soft Double-locked Stitch

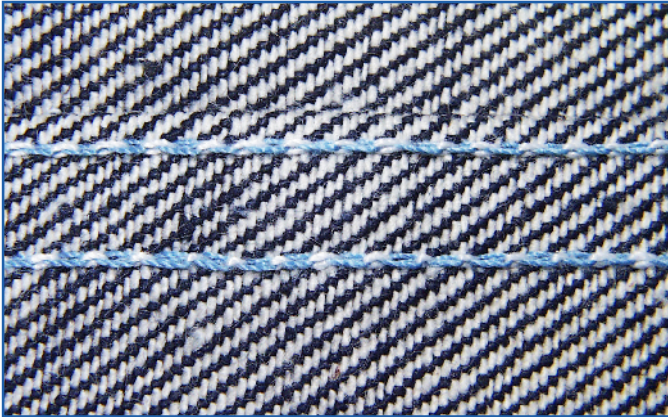

Standard Double-locked Stitch

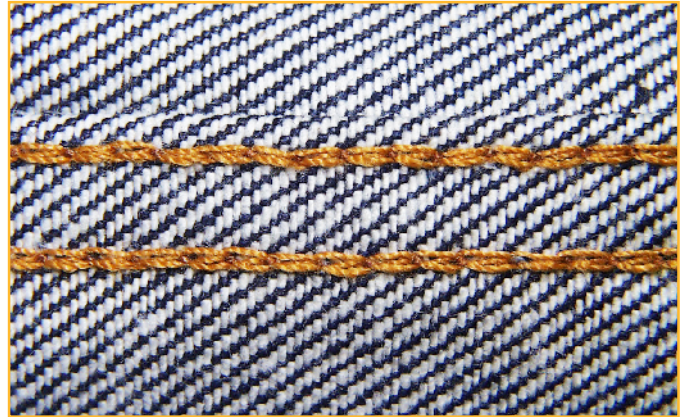

Soft Double-locked Stitch

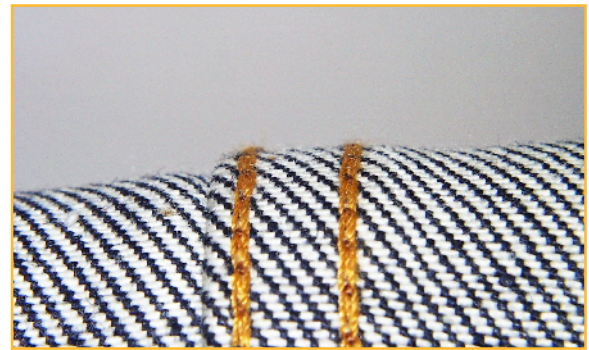
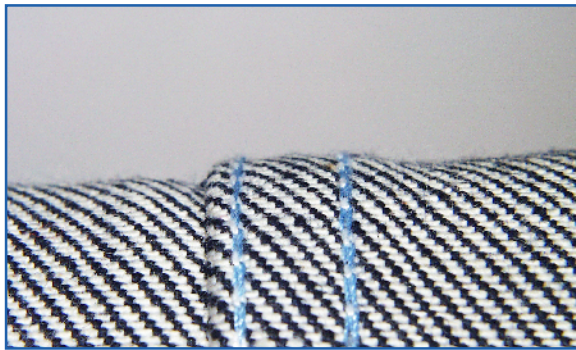

NOTE:

THIS MANUAL IS USED FOR CHANGING THE STANDARD PARTS TO SOFT DOUBLE-LOCKED STITCH PARTS ON BOTH THE DIFFERENTIAL AND PLAIN FEED 35800 MACHINES. THE STEPS ARE THE SAME FOR BOTH MACHINE TYPES EXCEPT WHERE NOTED.

PROCEDURE FOR REMOVAL OF STANDARD STITCH PARTS

Step 1A. Remove screw for control lever connecting link. Remove 2 screws for front head cover, then remove cover. Remove control lever assembly and nipper plate assembly. Attach control lever assembly and nipper plate assembly to new cover supplied with kit.

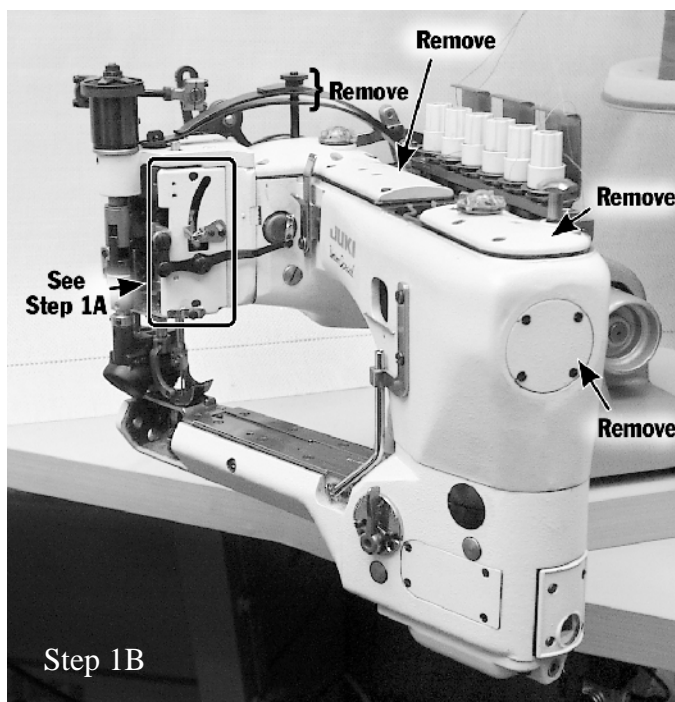
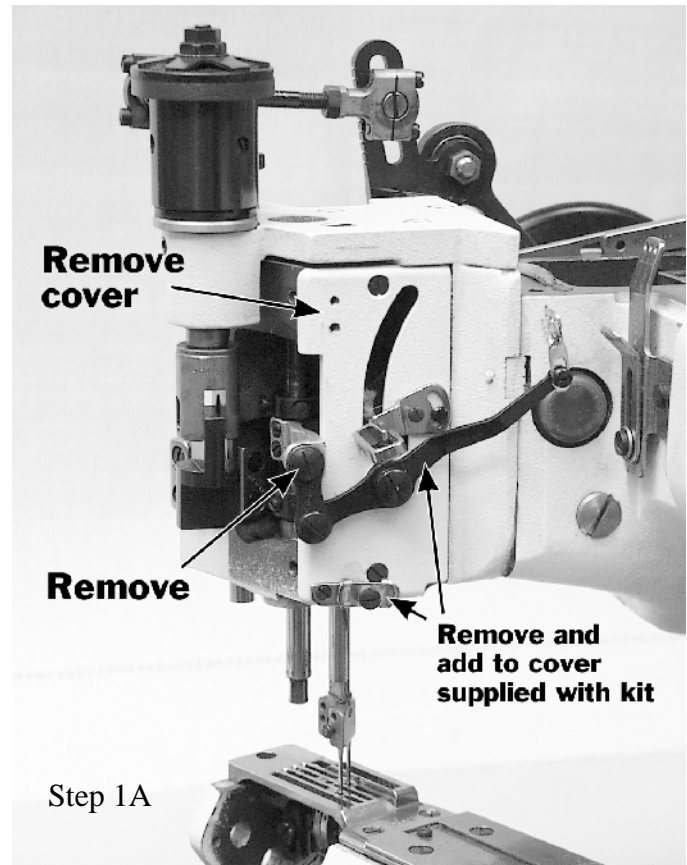

Step 1B. Remove pressure regulating screw, spring plate and upper and lower leaf springs. Remove 9 screws for chamber cover, then remove cover and gasket. Remove 6 screws for front top cover, then remove cover and gasket. Remove 4 screws for main frame end cover, then remove cover and gasket.

REMOVAL PROCEDURE, continued

Step 1C. Remove screw for plastic oil reservoir, then remove reservoir.

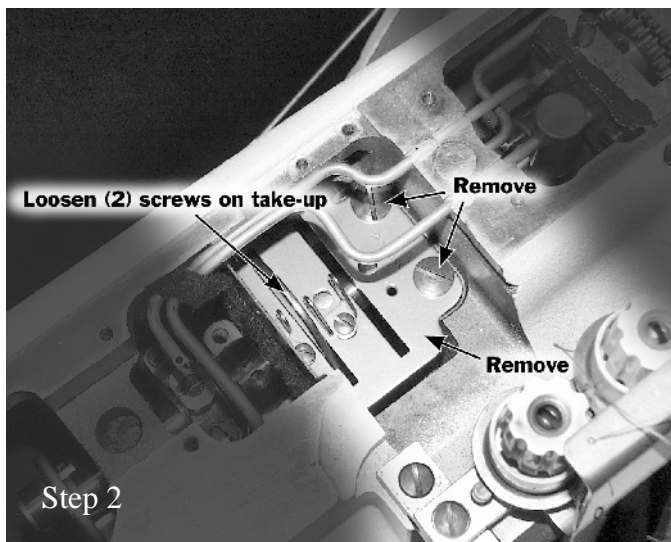
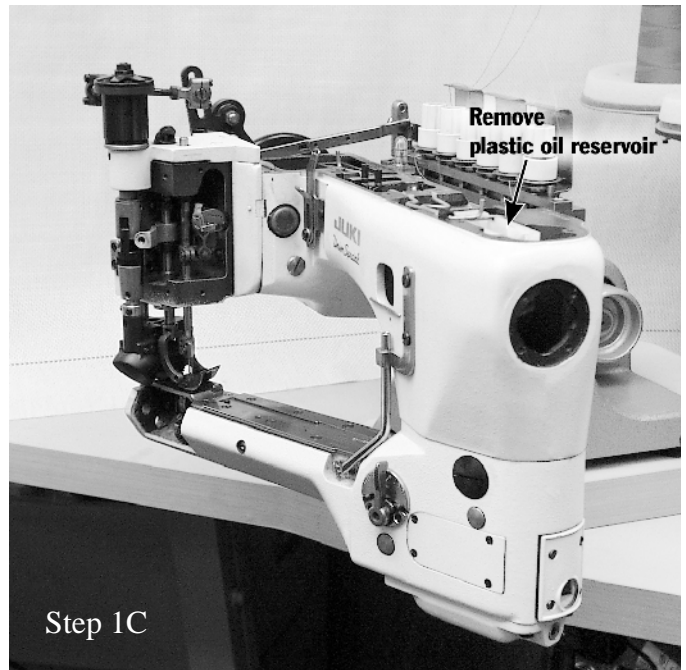

Step 2. Remove 2 screws from cast off plate, then remove plate. Loosen **but do not remove** 2 screws for take up cam.

Step 3. Remove screw for stop shaft washer, then remove washer. Carefully slide looper drive connection from end of mainshaft.

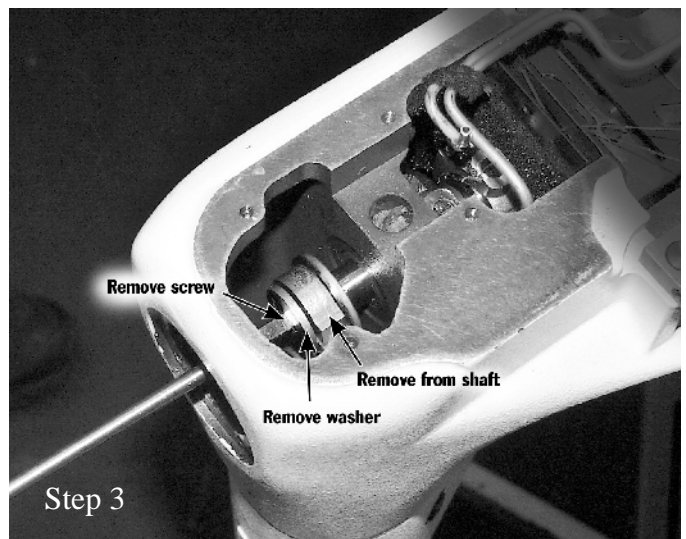

NOTE: For **differential** feed machines, follow Steps 4A and 4B.
For **plain** feed machines, go to Step 5.

Step 4A. Loosen 2 cap screws for feed lift eccentric assembly, and remove top half of eccentric strap. **Note strap position when removing—strap must be reinstalled later in same position to avoid binding.**

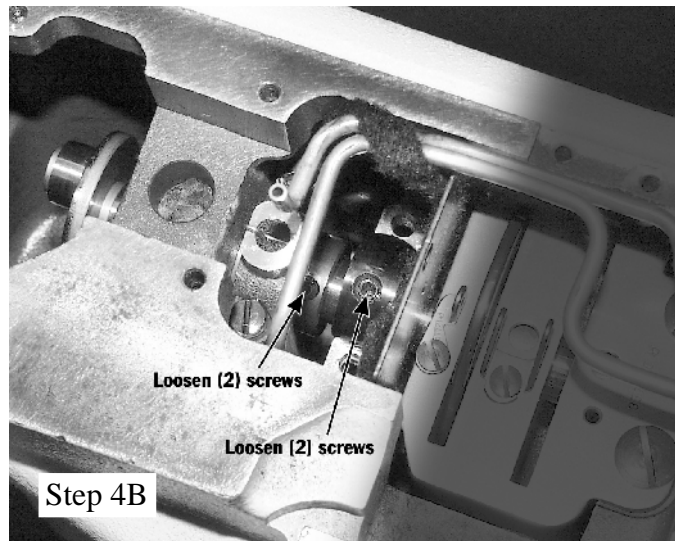
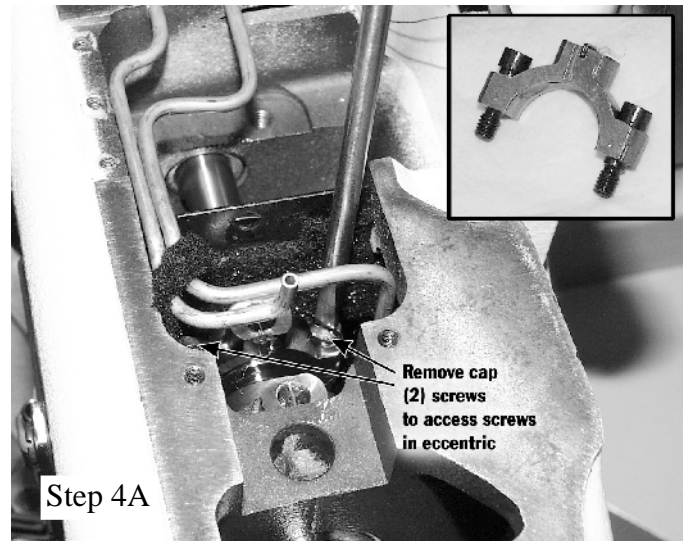

Step 4B. Loosen 2 screws in feed lift eccentric and 2 screws in feed drive eccentric just enough so that eccentrics will turn freely on shaft.

Step 5. Loosen 2 screws in the double feed eccentric assembly just enough so eccentric will move freely.

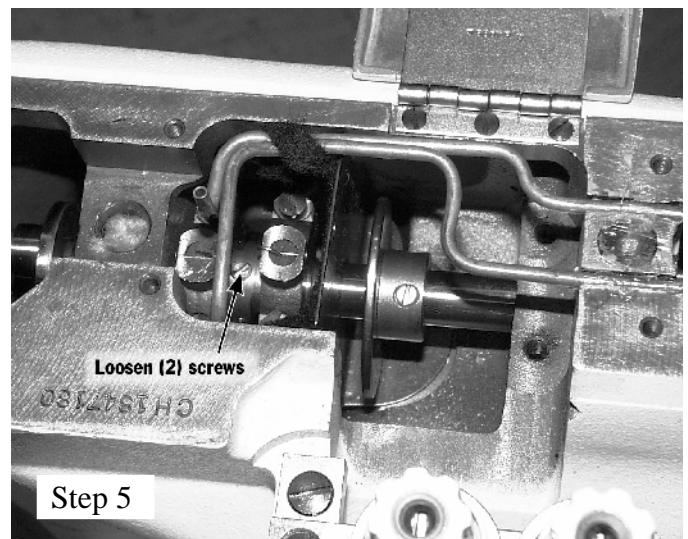

REMOVAL PROCEDURE, continued

- Step 6. Loosen 3 screws in mainshaft and crankshaft coupling just enough so that mainshaft will turn freely inside of coupling.

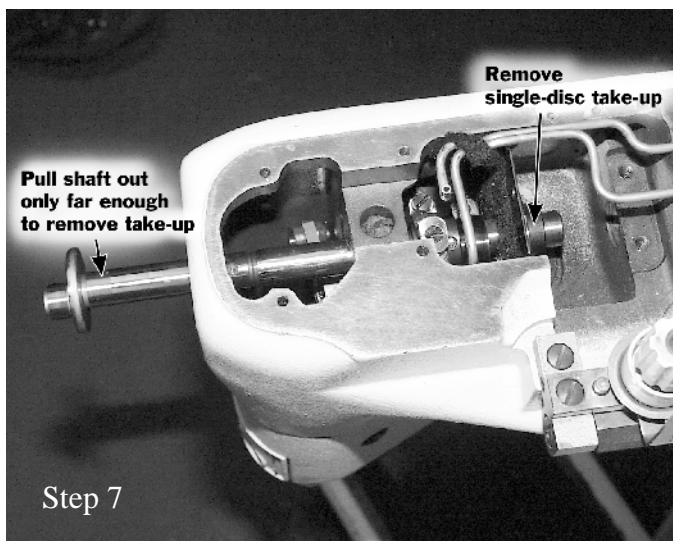
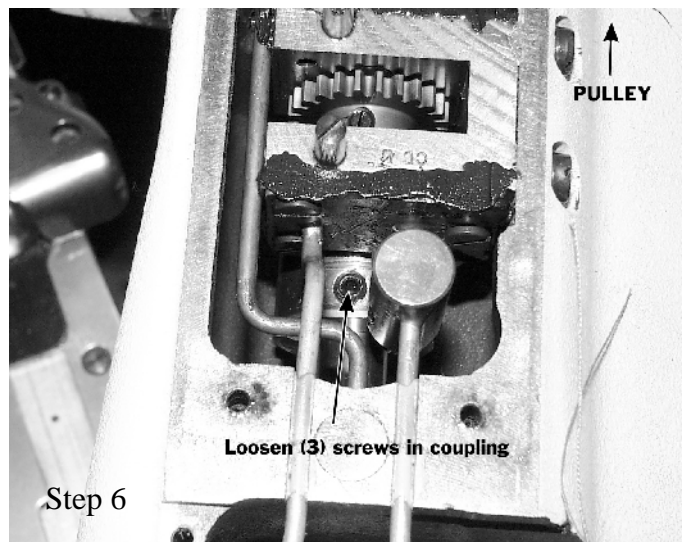

- Step 7. Pull mainshaft out from front of machine only far enough so that take up cam can be removed. Remove take up cam.

- Step 8. Lift presser foot and roller assembly, and remove standard throat plate.

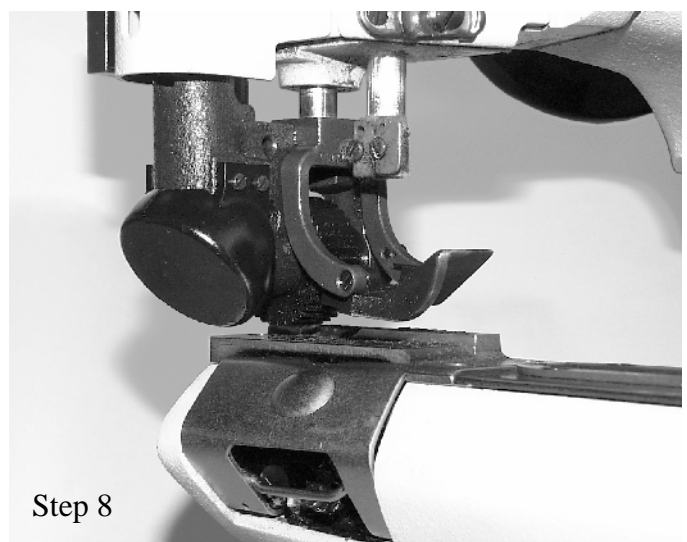

PROCEDURE FOR INSTALLATION OF SOFT STITCH PARTS

Locate and identify new parts from kit.

Step 9. Install new throat plate and release presser foot and roller assembly.

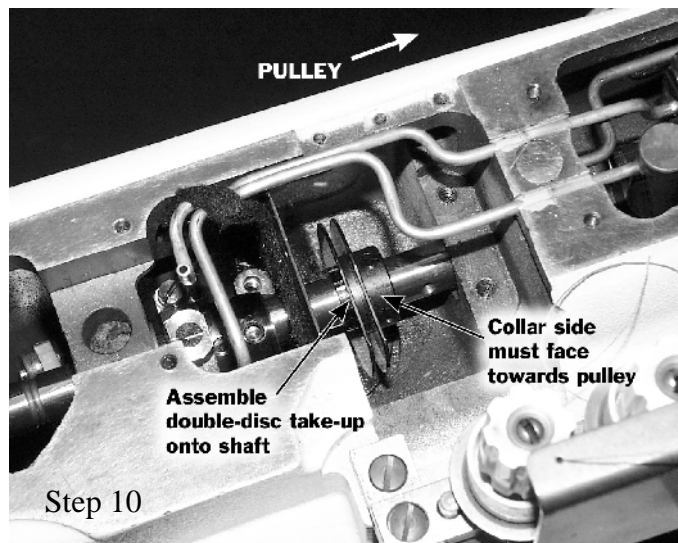
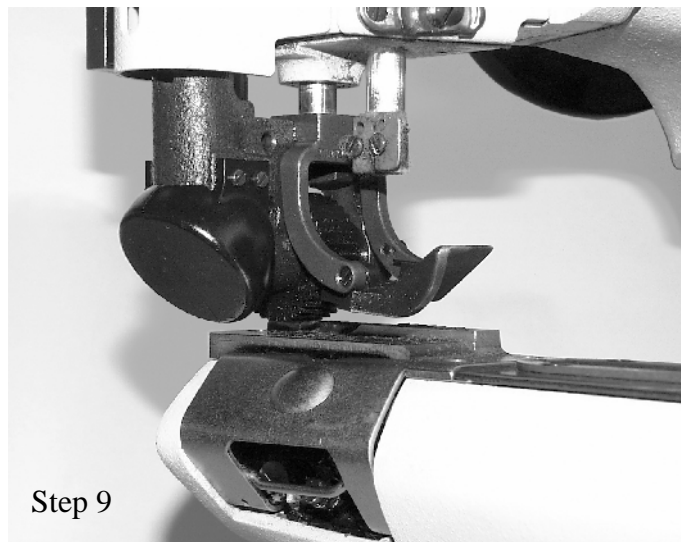

Step 10. Locate new double disc take up cam, and slide cam onto end of mainshaft with collar side toward the pulley end of the machine.

Step 11. Push mainshaft towards pulley end of machine until timing spot in the mainshaft aligns with spot screw in coupling. Tighten spot screw into spot of mainshaft and then tighten remaining 2 screws.

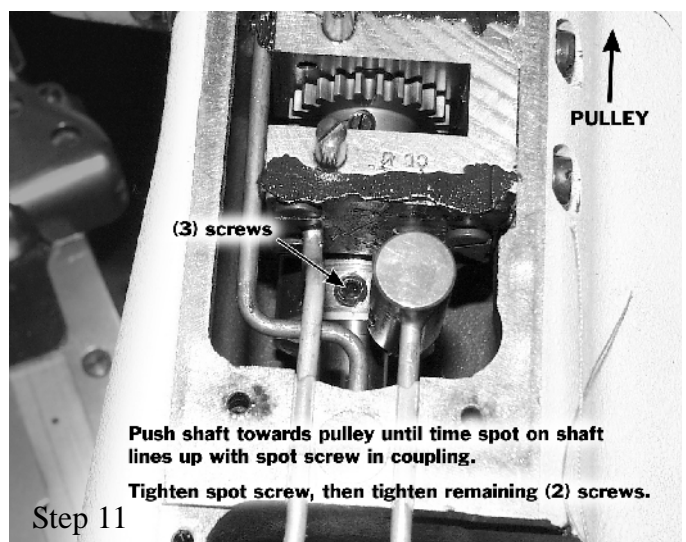

INSTALLATION PROCEDURE, continued

Note: For **differential** feed machines follow Steps 12A, 12B and 12C.
For **plain** feed machines follow Step 13.

Step 12A. Align spot screw in feed lift eccentric with spot in mainshaft and tighten spot screw, then tighten remaining screw.

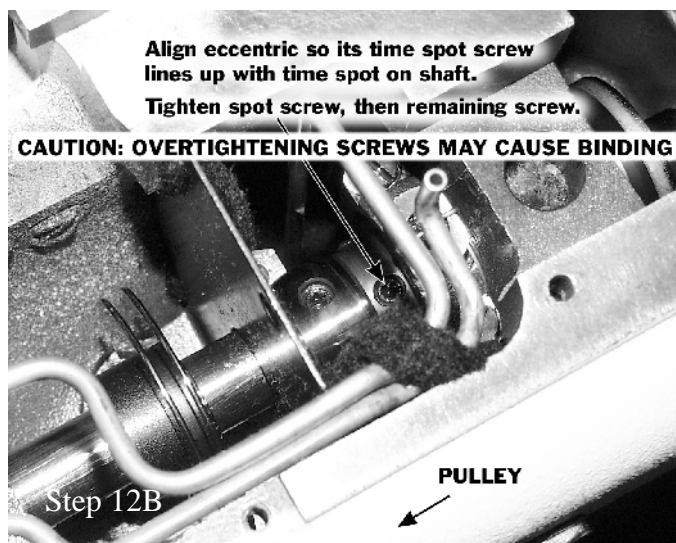
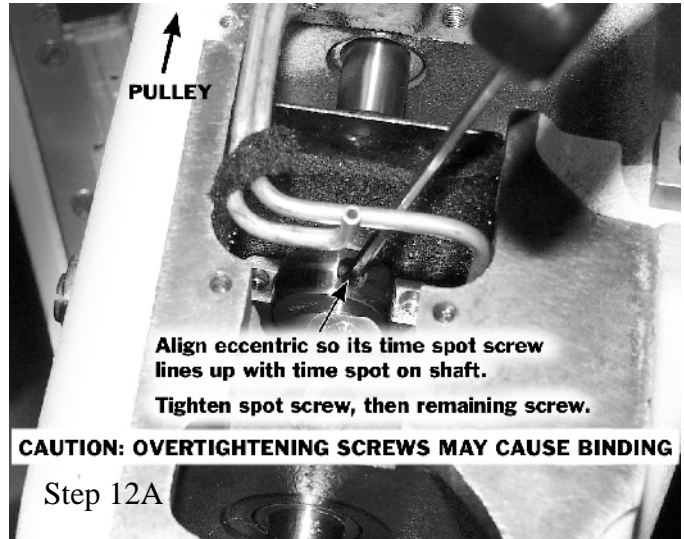

Step 12B. Align spot screw in feed drive eccentric with spot in mainshaft and tighten spot screw, then tighten remaining screw.

Step 12C. Locate top half of eccentric strap which was removed previously. Reassemble strap in same position as it was prior to removal, and tighten screws. After assembly turn machine over for several revolutions to make certain machine does not bind. If machine binds, check strap position and repeat step 15.



Step 13. Align spot screw in double feed eccentric assembly with spot in mainshaft and tighten spot screw, then tighten the remaining screw.

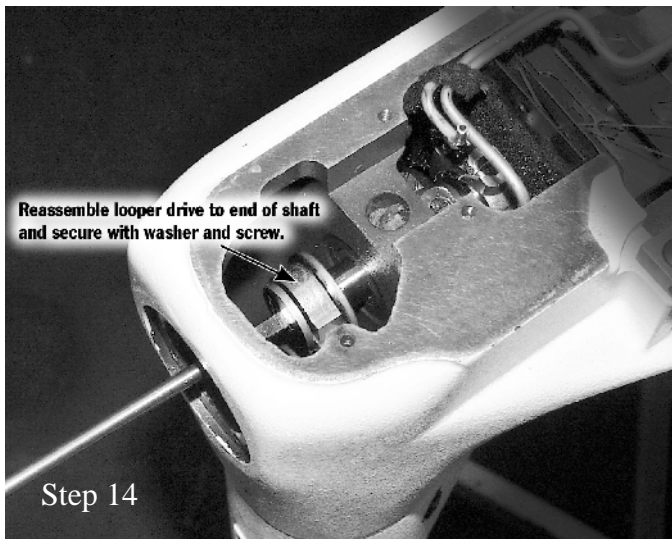
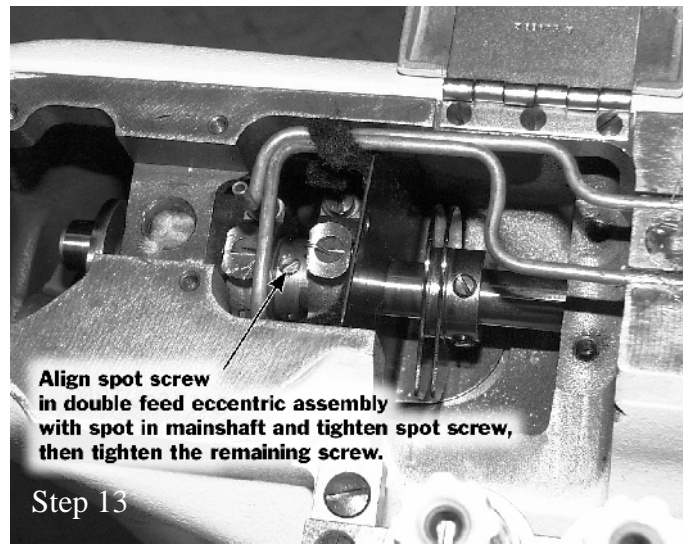

Step 14. Reassemble looper drive to end of mainshaft, replace washer and tighten in place with screw.

Step 15. A) Assemble new cast off plate and eyelet from kit and tighten with 2 screws.
B) Center double disc take up so that cast-off plate is centered between the take up discs.

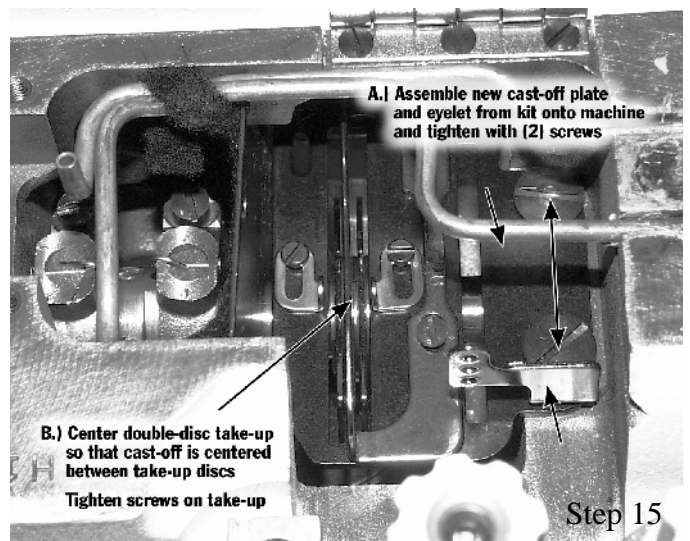

INSTALLATION PROCEDURE, continued

- Step 16. A.) Assemble new front head cover and gasket to machine with its 2 screws.
B.) Attach connecting link to lever with its screw.

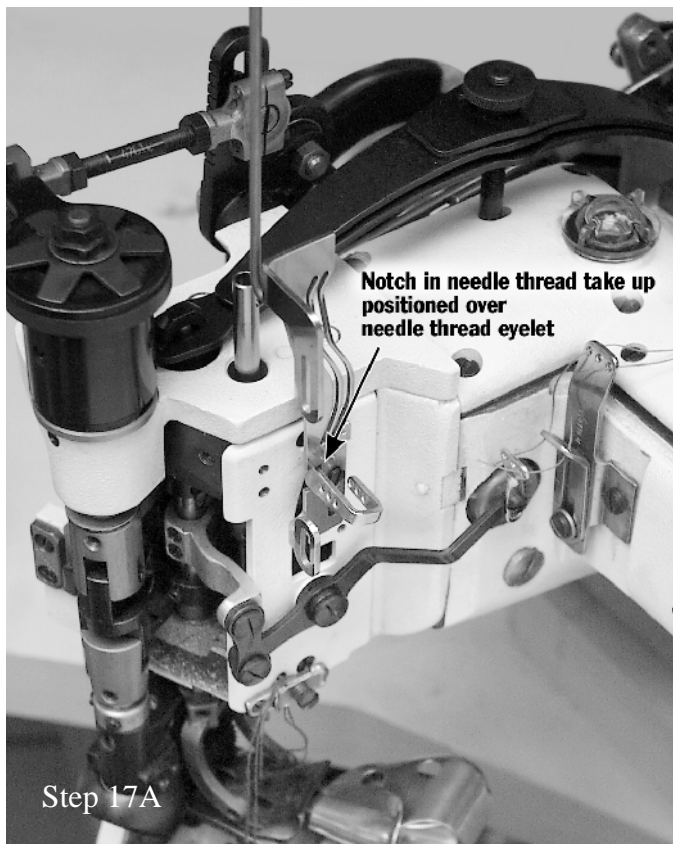
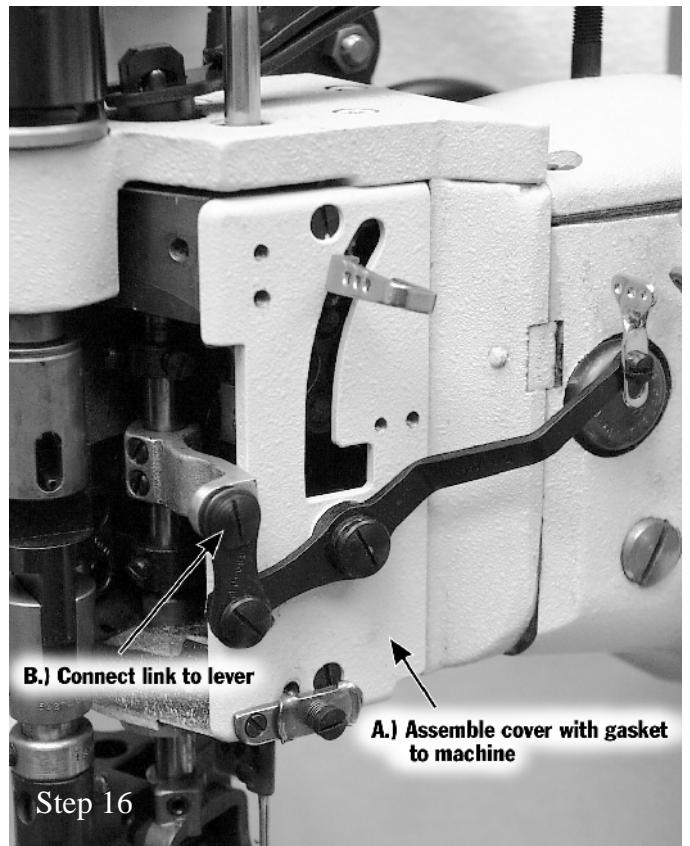

- Step 17A. With needle bar at top of stroke, position new needle thread take-up so that notch in take-up fits over needle thread eyelet.

Step 17B. Rotate take-up clockwise, lower it into position over control lever, and attach to cover with its two screws.

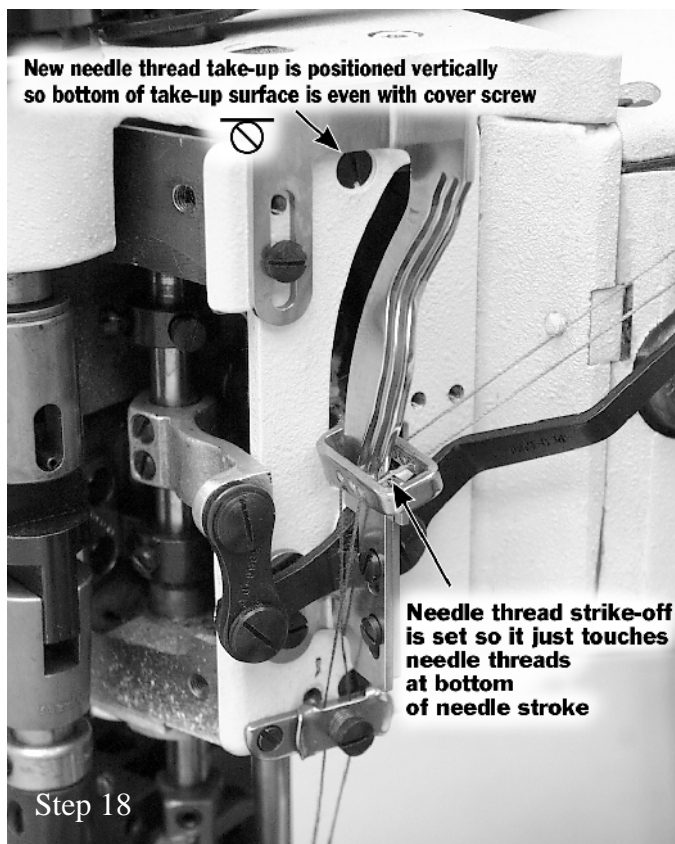

Step 18. Position new needle thread take-up vertically so bottom of take-up surface is even with top of cover screw.

Thread machine so that one needle thread passes through each hole in needle lever thread eyelet.* Needle thread strike-off is set so it just touches needle threads at bottom of needle stroke.

*Same as standard threading.

INSTALLATION PROCEDURE, continued

Step 19A. Reassemble plastic oil reservoir with its screw.

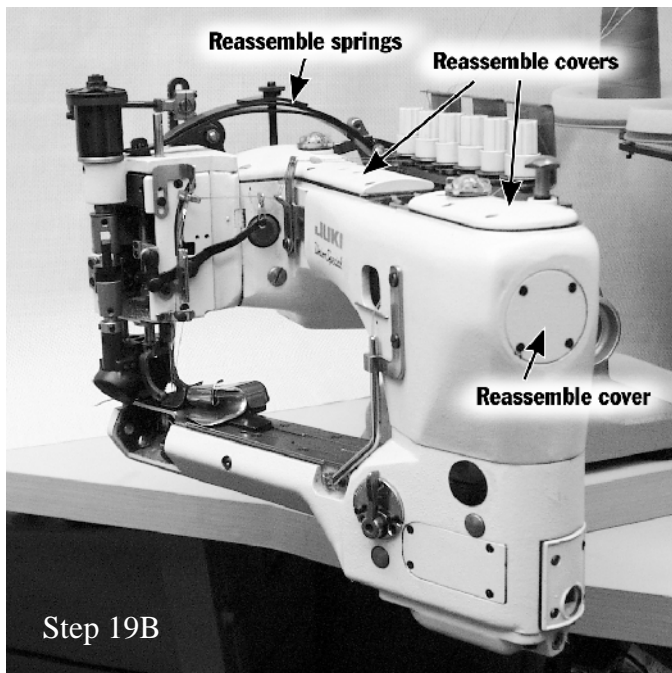
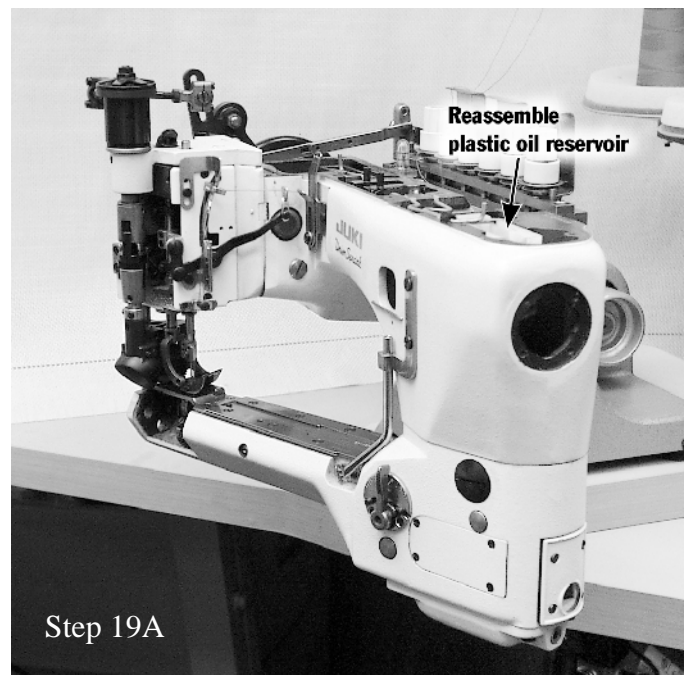

Step 19B. Reassemble chamber cover, top cover, main frame end cover and presser foot tension springs.

Step 19C. Remove Loper thread guide wire and slide spring from kit over the wire and then replace guide wire on machine.

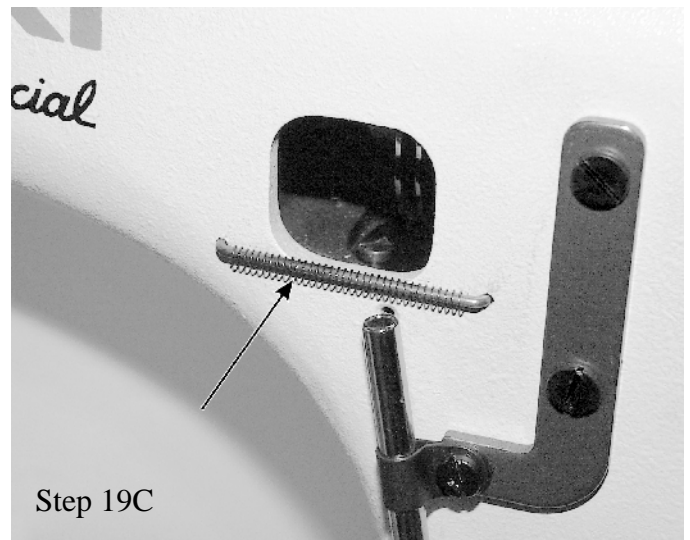

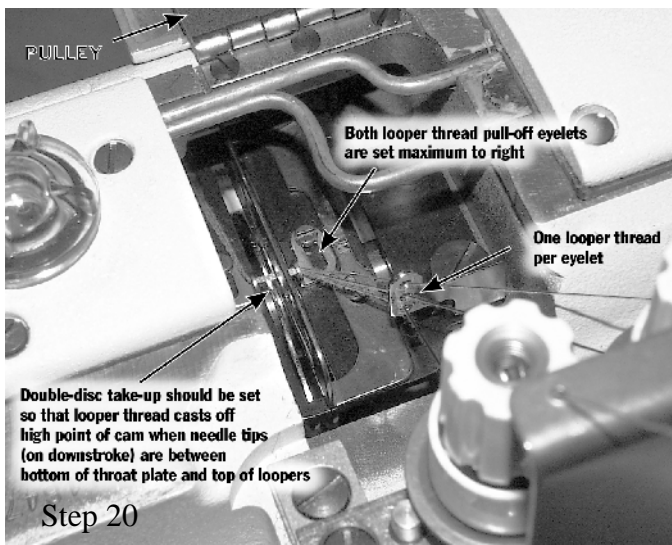

Step 20 Set both looper thread pull-off eyelets maximum to the right. Set double disc take-up cam so that looper thread casts off from high point of cam when tips of the needles on down stroke are between bottom of throat plate and top of loopers. Thread one looper thread through each hole in new eyelet from kit.

Step 21 Set needle thread tensions to high, so that needle threads are pulled up very tight against material. Set looper thread tensions to low, so that maximum amount of looper thread is in the material.

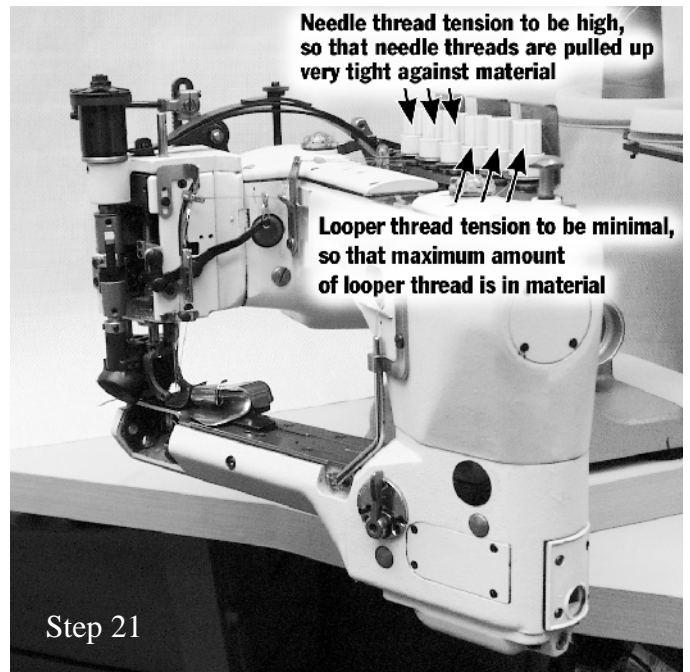

Union Special Corporation
Corporate Office
One Union Special Plaza
Huntley, IL 60142
Phone: 847•669•5101
Fax: 847•669•4454

Union Special GmbH
European Distribution Center
Raiffeisenstrasse 3
D-71696 Möglingen, Germany
Tel: 49•07141•247•0
Fax: 49•07141•247•100

JUKI CORPORATION
INTERNATIONAL SALES DIVISION
8-2-1, KOKURYO - CHO,
CHOFU-SHI, TOKYO 182, JAPAN
PHONE: 03(3430)4001-5
FAX: 03(3430)4909 . 4914 . 4984



JUKI
Union Special